





SUPPORT SYSTEMS

Programme	Page Nr.
Cable Outlets	9.01
Shelf Supports	9.01
Glass Supports	9.02
Shelf Studs	9.02



ASSEMBLY FITTINGS

Programme	Page Nr.
Screws	9.03
Knock Down Fittings	9.04
Table Legs & Wardrobe Rail	9.05
Cam & Dowel Fittings	9.06



MISCELLANEOUS FITTINGS

Programme	Page Nr.
Door Buffers	9.08
Cover Caps	9.08
High Grade Silicon	9.08
Mitre Bond	9.08



LOCK Programme

Programme	Page Nr.
Cylinder Cores - Keyed Different	9.09
Cylinder Cores - Keyed Alike	9.09
Master Keys	9.10
Rim Locks & Striking Plates	9.10

Standard Plastic Grommet

Art. No.	Hole Diameter & Depth	Finish	Packing
CO20011BL	80mm Diameter & 22mm Depth	Black	1/100
CO20011BR	80mm Diameter & 22mm Depth	Brown	1/100
CO20011GR	80mm Diameter & 22mm Depth	Grey	1/100



DREIKA Metal Grommet

Art. No.	Hole Diameter & Depth	Finish	Packing
CO20084SN	80mm Diameter & 22mm Depth	Satin Nickel	1/8



Independent Shelf Supports

Art. No.	Finish	Shelf Thickness	Shelf Depth	Max Weight	Packing
JD76531SS	Stainless Steel	3-15mm	Max 160mm	10kg	1 Set



Metal Shelf Stud for 5mm Holes

Art. No.	Drilling Dimensions	Finish	Packing
SS144NI	5mm	Nickel	5000



Paddle Shelf Stud for 5mm Holes

Art. No.	Drilling Dimensions	Finish	Packing
SS10NI	5mm	Nickel	5000



Shelf Supports



Shelf Support with Suction Cup for Glass

Art. No.	Drilling Dimension	Finish	Packing
SS01NI	5mm Diameter	Nylon/Nickle	2500



Nail In Shelf Stud with Metal Pin

Art. No.	Finish	Packing
SS340350WH	White	1000
SS340350BE	Beige	1000
SS340350BR	Brown	1000

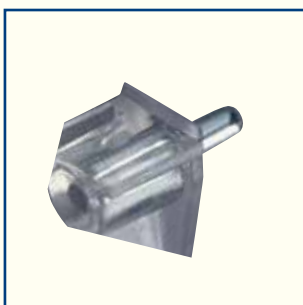

Plastic Shelf Stud with Metal Pin for 5mm Holes

Art. No.	Drilling Dimension	Finish	Packing
SS7855NY	5mm Diameter	Transparent/Metal	2500

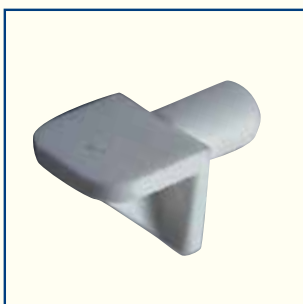

Plastic Shelf Stud for 5mm Holes

Art. No.	Drilling Dimension	Finish	Packing
SS7853BE	5mm Diameter	Beige	1000



Modesty Block

Art No	Finish	Packing
NM0675WH	White	1000
NM0675BE	Beige	1000

SPAX-S Screws		
Art. No.	Size	Packing
SPAX35X15	3.5mm x 15mm	1000
SPAX35X16	3.5mm x 16mm	1000
SPAX35X17	3.5mm x 17mm	1000
SPAX35X20	3.5mm x 20mm	1000
SPAX35X25	3.5mm x 25mm	1000
SPAX35X30	3.5mm x 30mm	1000
SPAX35X40	3.5mm x 40mm	1000
SPAX35X50	3.5mm x 50mm	500
SPAX40X16	4mm x 16mm	1000
SPAX40X17	4mm x 17mm	1000
SPAX40X20	4mm x 20mm	1000
SPAX40X25	4mm x 25mm	1000
SPAX40X27	4mm x 27mm	1000
SPAX40X30	4mm x 30mm	1000
SPAX40X35	4mm x 35mm	1000

SPAX-S Screws		
Art. No.	Size	Packing
SPAX40X40	4mm x 40mm	1000
SPAX40X50	4mm x 50mm	500
SPAX40X60	4mm x 60mm	500
SPAX40X70	4mm x 70mm	500
SPAX40X80	4mm x 80mm	200
SPAX45X25	4.5mm x 25mm	1000
SPAX45X60	4.5mm x 60mm	500
SPAX5X30	5mm x 30mm	500
SPAX5X40	5mm x 40mm	500
SPAX5X50	5mm x 50mm	200
SPAX5X60	5mm x 60mm	500
SPAX5X70	5mm x 70mm	200
SPAX5X80	5mm x 80mm	200
SPAX5X90	5mm x 90mm	200
SPAX5X100	5mm x 100mm	200



- Spax-S Chipboard Screws
- Countersunk Heads
- Zinc Plated

JD Plus Screws		
Art. No.	Size	Packing
JDP35X15	3.5mm x 15mm	1000
JDP35X16	3.5mm x 16mm	1000
JDP35X17	3.5mm x 17mm	1000
JDP35X20	3.5mm x 20mm	1000
JDP35X25	3.5mm x 25mm	1000
JDP35X30	3.5mm x 30mm	1000
JDP35X35	3.5mm x 35mm	1000
JDP35X40	3.5mm x 40mm	1000
JDP35X45	3.5mm x 45mm	1000
JDP35X50	3.5mm x 50mm	500
JDP4X16	4mm x 16mm	1000
JDP4X17	4mm x 17mm	1000
JDP4X20	4mm x 20mm	1000
JDP4X25	4mm x 25mm	1000
JDP4X30	4mm x 30mm	1000
JDP4X35	4mm x 35mm	1000

JD Plus Screws		
Art. No.	Size	Packing
JDP4X40	4mm x 40mm	1000
JDP4X45	4mm x 45mm	500
JDP4X50	4mm x 50mm	500
JDP4X60	4mm x 60mm	500
JDP4X70	4mm x 70mm	200
JDP5X30*	5mm x 30mm	<i>Special Order</i>
JDP5X40	5mm x 40mm	500
JDP5X50	5mm x 50mm	500
JDP5X60	5mm x 60mm	500
JDP5X70	5mm x 70mm	200
JDP5X80	5mm x 80mm	200
JDP5X90	5mm x 90mm	200
JDP5X100	5mm x 100mm	200
JDP6X100*	6mm x 100mm	<i>Special Order</i>
JDP6X120*	6mm x 120mm	<i>Special Order</i>
JDP6X140*	6mm x 140mm	<i>Special Order</i>



The multi purpose screw is suitable for most applications, hard wood, soft wood, chipboard, PVC and many other materials. Other head designs and material are available to suit your application. Featuring optimised head design, low driving torque, the JD Plus drives in without any splitting.

*= Are available by special order.

Please contact your sales representative or Head office for further details.

BLUM Knock Down Fittings



Blum KD c/w Steel Screw

Art. No.	Part	Finish	Packing
KD420110WH	Housing	White	2500
KD420110BE	Housing	Beige	2500
KD420110BR	Housing	Brown	2500
KD420720	Bolt	Zinc	2500

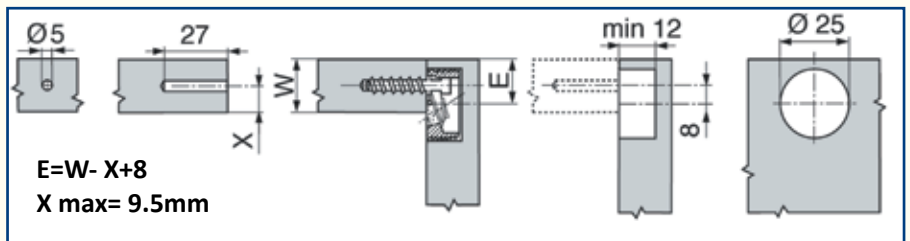
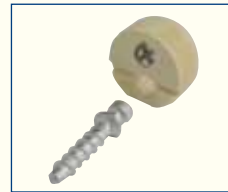
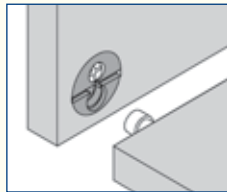

Blum KD c/w Plastic Dowel & Pin

Art. No.	Part	Finish	Packing
KD400110NWH	Housing	White	2500
KD400110NBE	Housing	Beige	2500
KD400110NBR	Housing	Brown	2500
KD400220	Dowel		2500
KD400130	Pin		2500

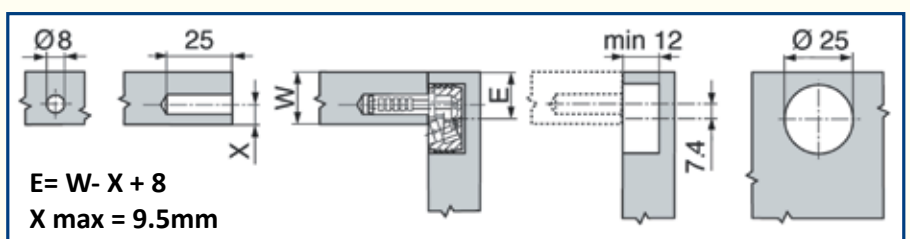
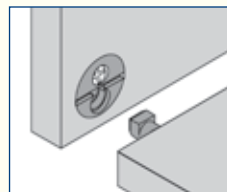

100 mm Adjustable Leg (Set)

Art No	Packing
HAJ100X4	1 Set / 50 Sets

- 100 mm high leg (-10 mm / +28 mm)
- Wide threads for easy adjustments
- 1 Set = 4 legs + 2 plinth clips



150 mm Adjustable Leg (Set)

Art No	Packing
HAJ150X4	1 Set / 50 Sets

- 150 mm high leg (-10 mm / +28 mm)
- Wide threads for easy adjustments
- 1 Set = 4 legs + 2 plinth clips



Oval Robe Rail

Art. No.	Dimensions	Length	Finish	Packing
RR30x15x3C	30 x 15mm	3000mm	Chrome	1/ 10



End Bracket for Wardrobe Rail

Art No	Packing
RR990020NI	1 / 500

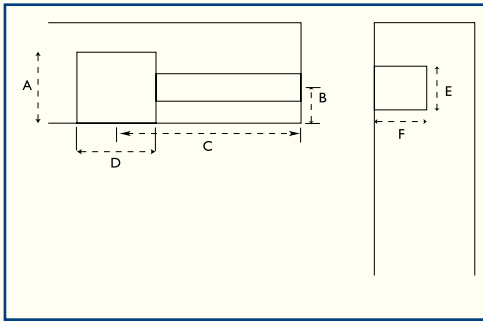

Table Leg / Counter Support 60mm Diameter

Art. No.	Length	Finish	Packing
L4816SS	710mm	Stainless Steel	4 Pcs
L4817C	870mm	Chrome	4 Pcs
L4817SS	870mm	Stainless Steel	4 Pcs
L4718SS	1100mm	Stainless Steel	1 Pc



Cam & Dowel



Cam and Dowel

- Quick & Easy Assembly
- 15mm diameter Cam Ex Stock
- Range Of Dowels
- Zinc Finish - Further finishes available by special order



15mm Diameter Cam

Art. No.	Finish	Packing
MF7303/15	Zinc / Nickel Plated	1000
MF7303/18	Zinc / Nickel Plated	1000

MF7303/15 - A= 12mm B= 7.5mm D= 15mm
 MF7303/18 - A= 12mm B = 9.5mm D= 15mm



Pozi Drive Bolt (8 mm Diameter Hole)

Art. No.	Finish	Packing
MF7165/20	Zinc / Nickel Plated	1000
MF7165/30	Zinc / Nickel Plated	1000

MF7165/20 - C= 24mm E= 5mm F= 12mm
 MF7165/30 - C= 34mm E =5mm F= 12mm



Inserta Bolt (8 mm Diameter Hole)

Art. No.	Finish	Packing
MF7272/34	Self Coloured	1000

MF7272/34 -C = 34mm E = 8mm F = 12mm



Timber Dowels

Art. No.	Diameter	Length	Packing
TD8x30	8mm	30mm	10kg
TD8x35	8mm	35mm	10kg
TD8x40	8mm	40mm	10kg
TD8x50	8mm	50mm	10kg
TD10x40	10mm	40mm	10kg
TD10x50	10mm	50mm	10kg

Connecting Block & Cap

Art. No.	Part	Finish	Packing
603840	Block	White/Beige/Brown	1000
603850	Cap	White/Beige/Brown	1000



Euro Screw

Art. No.	Sizes	Diameter	Finish	Packing
JD7472	6.3 x 11mm	5mm diameter	Nickel	1000



Worktop Connecting Bolts

Art. No.	Sizes	Drilling Dimensions	Finish	Packing
WC7787	150mm	35mm diameter	Self Colour	20 / 200



Angle Bracket (Small)

Art. No.	Dimensions	Finish	Packing
NM3155SC	19mm x 19mm	Self Coloured	1000
NM3155ZP	19mm x 19mm	Zinc Plated	1000



Miscellaneous



Stick on Door Buffers

Art. No.	Dimensions	Finish	Packing
JD7843	10mm Diameter	Transparent	50 per Card



Acrylic "Painters Mate"

Art. No.	Size	Finish	Packing
JD8613WH	310ml	Transparent	1 / 12



Mitre Bond

Art No	Size	Packing
JDMB	200ml Activator + 50ml Adhesive	1 / 10



Stick on Cover Caps

Art. No.	Dimensions	Finish	Packing
ASC13BE	13mm Diameter	Beech	20 per Card / 2000
ASC13CR	13mm Diameter	Cream	20 per Card / 2000
ASC13GR	13mm Diameter	Grey	20 per Card / 2000
ASC13OK	13mm Diameter	Oak	20 per Card / 2000
ASC13PI	13mm Diameter	Pine	20 per Card / 2000
ASC13WH	13mm Diameter	White	20 per Card / 2000

Cylinder Cores



Key Changes
A001-A20

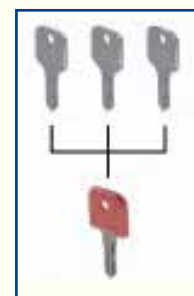

Master Key
MKA1

Our entire lock Programme is supplied with separate cores and lock housings. This unique method of supply offers numerous advantages including:

- Full Master Key and General Master Key Programme
- Lock housings can be fitted and configuration for key numbers can be decided by customers later.
- No keys lost during transport.
- No searching for matching keys on site
- Easy on site assembly.
- Core can be removed with special removal key in the event of lost or stolen keys.
- Configuration can be changed without the need for new locks.
- Reduced costs.

The Cylinder Core can be fitted effortlessly to numerous lock housings. Each Cylinder Core comes complete with Core, 1 flap key and 1 standard key. The lock code is marked on the keys and core. You can choose from keyed alike or keys to differ.

Cylinder Core- Keyed Different

Keys to Differ - Key Numbers	Art. No.
A001 - A200 (Master Programme A1)	MB1021.061
A201 - A400 (Master Programme A2)	MB1021.261
A401 - A600 (Master Programme A3)	MB1021.461

Cylinder Core-Keyed Alike Master Programme A1

Key No.	Art No.
001	MB1021.001
002	MB1021.002
003	MB1021.003
004	MB1021.004
005	MB1021.005
006	MB1021.006
007	MB1021.007
008	MB1021.008
009	MB1021.009
010	MB1021.010

Cylinder Core-Keyed Alike Master Programme A1

Key No.	Art No.
011	MB1021.011
012	MB1021.012
013	MB1021.013
014	MB1021.014
015	MB1021.015
016	MB1021.016
017	MB1021.017
018	MB1021.018
019	MB1021.019
020	MB1021.020

Lock Programme



Master Keys			
Art.No.	Colour	Mark	Master Programme
MB1011.016	Red	MK A1	A1
MB1011.006	Orange	GMK A	A1 - A3





Core Removal Keys			
Art.No.	Colour	Mark	Master Programme
MB1011.106	Yellow	IK A	A1 - A3

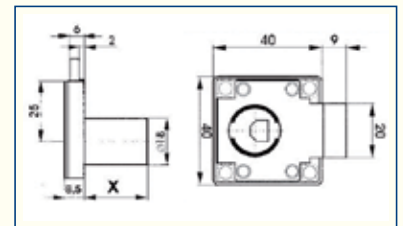

Rim Lock Left / Right			
Art. No.	Backset	Dimen X	Packing
MB1061.000	25 mm	22mm	20 / 100

The lock can be reversed from right to left opening by moving the pre-installed pin



Striking Plate		
Art No	Dimensions	Packing
MB1451.060 	12 x 12 x 40mm	20/100

